

# OL100 LED Based Low Intensity Obstruction Light

In some cases, a country has its own Aviation regulation other than ICAO regulation. For example, Germany and Australia require more intensity from their local Aviation Authorities. REDDOT can make such light base on customer's request.

Double light for customized low intensity series

Double light is integrated by 2 single lights. For making sure there is always a light working atop of the tower. Two optional working patterns can meet different area's customers.

"Service+Standby": Only "service light" is working normally. It will auto-transfer to "standby light" in case of "service light" failure

"Service+Service": Two single lights work simultaneously. Either failure will not affect the other normal working.

## Features

- Special optical design provides better light distribution
- LED light source ensures long lifetime, maintenance free
- Low power consumption
- Shock and vibration resistant
- Corrosion resistant and UV stable polycarbonate housing
- Ease of mount, mount accessories available
- Available both in single and double type
- 5 years warranty

## Application

- Telecomm tower
- Radio tower
- Wind turbine
- Smoke stacks & chimney
- Tall building
- Crane
- Power transmission line



# Specifications



LIGHT OUTPUT	OL100S(Single)	OL100DST ①(Double)	OL100DSS ②(Double)
Effective Intensity	100 Candela	100 Candela	100 Candela
Vertical Divergence	10 Degree		
Horizontal	360 Degree		
LED color	Red		
LED lifespan	100,000 Hours		

OPERATION	
Flash Pattern	Steady burning(default)

POWER SUPPLY	
Input voltage	110-220VAC, 50/60 Hz;12VDC;24VDC;48VDC
Power Consumption	8W                      8W                      16W

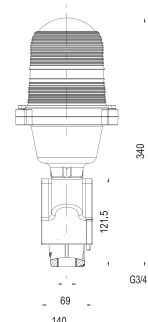
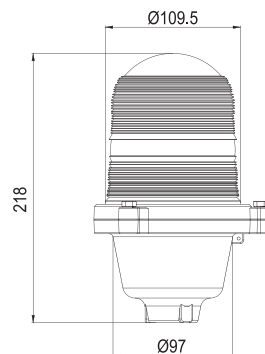
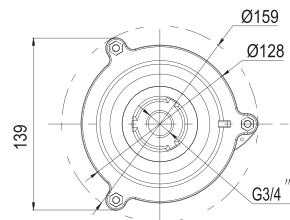
MACHANICAL STRUCTURE	
Lens	Polycarbonate,UV Stabilized
Body	Die-casting Aluminum
Water-proof	IP65
Weight	0.9KG                      3.5KG                      3.5KG
Dimension	159mmx245mm    340mmx413mmx140mm    340mmx413mmx140mm
Mounting Size	Threaded 3/4" bottom hub
Temperature Range	-40C° ~ +55C°
Relative Humidity	100% with condensation
Wind speed	Up to 150mph(240kph)
Warranty	5 years
Optional	Available in flashing pattern(40FPM) Available with built-in photosensor Available with built-in alarm relay contacts



 ① ST: "Service+Standby"     
  ② SS:"Service+Service"

## Order codes

Series	Single/Double	AC/DC	Voltage	Flashing	Photosensor	Alarm relay	Pattern(For double light only)
OL100	S	A	12	F	P	R	ST
	D	D	24				SS
			48				
			110				
			220				

For example, OL100SA220PST means OL100 double light, AC220V power supply, red steady burning, with built-in photosensor, "service+standby"

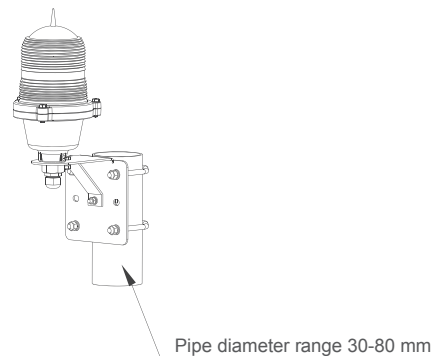

Ordering Code: AKU80  
Mounting kit for 30-80mm vertical or horizontal pipe

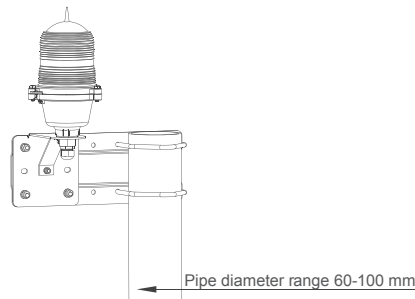

Ordering Code: AKU100  
Mounting kit for 60-100mm vertical | pipe

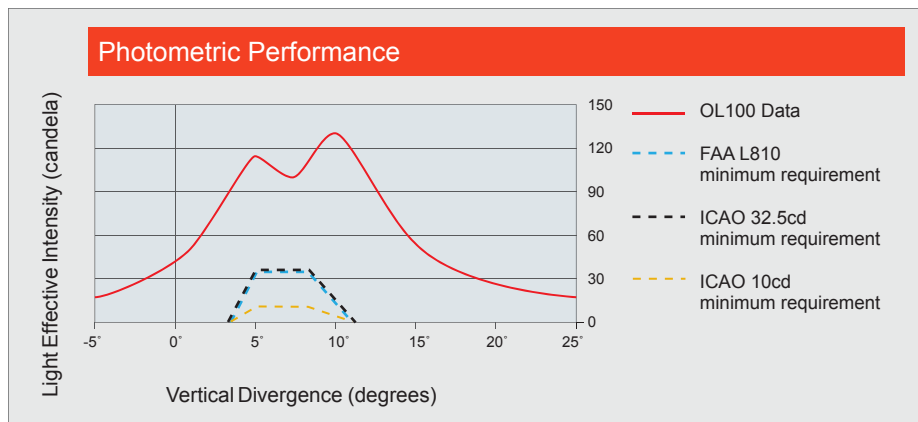



ESPECIALIDADES DE INGENIERÍA APLICADA  
Venta y Distribución de Materiales Eléctricos  
Tel 02-7914900 Fax 02-7328875  
ventas@balizas.cl



REPRESENTANTE PARA CHILE  
Balizas.cl